

**MODEL: E88A**

**BUILT-IN ELECTRIC OVENS**

**Installation and operating instructions**

Dear Customer,

Thank you for selecting one of our products. We are certain it will respond fully to your needs and expectations, giving perfect results every time.

Please read this manual carefully. The instructions it contains will enable you to use the appliance correctly and to best advantage.

The manufacturer accepts no liability for damage to persons or property caused by incorrect and unsuitable installation.

The manufacturer reserves the right to apply such modifications to the appliance as are deemed appropriate, without any obligation to notify customers in advance.

## SAFETY PRECAUTIONS

- To avoid any possible hazard, the appliance may be installed by qualified personnel only.
- Any repairs by unqualified persons may result in electric shock or short circuit. In order to avoid possible injuries to your body or to the appliance, do not attempt any repairs by qualified service personnel.
- Hot fat is highly inflammable, so pay extra attention when preparing food with greas or oil.
- **Warning!** Never let small children in the vicinity of the oven; they are not yet aware of danger of burns. Older children may use the appliance only under your surveillance.
- The inside of the oven, also places of potential danger for children.
- **Danger of burns!** Oven and cooking accessories may become very hot during operation. To avoid burns use kitchen clothes and gloves when handling hot parts or utensils.
- Mains leak of adjacent appliances may be damaged by hotplates or if stuck between the oven doors, and produce short circuit, therefore keep them at safe distance from the appliance.
- **Take extra precautions when grilling. Intensive heat from infrared heater makes the oven and the accessories extremely hot. Use protective gloves and barbecue accessories!**
- **Perforated roast may produce spurting of hot grease (sausages). Use long grill tongs to prevent skin burns and protect your eyes.**
- **Supervise the grill at all times. Excessive heat may quickly burn your roast and provoke fire!**
- **Do not let the children in the vicinity of the grill.**
- **THIS APPLIANCE IS CONCEIVED FOR DOMESTIC USE ONLY. THE MANUFACTURER SHALL NOT IN ANY WAY BE HELD RESPONSIBLE FOR WHATEVER INJURIES OR DAMAGES ARE CAUSED BY INCORRECT INSTALLATION OR BY UNSUITABLE, WRONG OR ABSURD USE.**
- **THIS APPLIANCE IS NOT INTENDED FOR USE BY PERSONS (INCLUDING CHILDREN) WITH REDUCED PHYSICAL, SENSORY OR MENTAL CAPABILITIES, OR LACK OF EXPERIENCE AND KNOWLEDGE, UNLESS THEY HAVE BEEN GIVEN SUPERVISION OR INSTRUCTION CONCERNING USE OF THE APPLIANCE BY A PERSON RESPONSIBLE FOR THEIR SAFETY. CHILDREN SHOULD BE SUPERVISED TO ENSURE THAT THEY DO NOT PLAY WITH THE APPLIANCE.**
- **DO NOT PLACE TIN FOIL, PANS OR SIMILAR IN CONTACT WITH THE INNER BASE OF THE OVEN TO COOK. THE HEATING ACTION OF THE LOWER RESISTANCE CAUSES THE LOWER PART OF THE OVEN TO OVERHEAT, LEADING TO DAMAGE AND EVEN SERIOUS CONSEQUENCES (FIRE RISK) ALSO TO THE UNIT IN WHICH THE OVEN IS INSTALLED.**

## GENERAL INFORMATION

The oven data plate remains accessible following installation, and is exposed to view simply by opening the door. It shows all details needed to identify the appliance, and these must be indicated when ordering replacement parts.

MADE IN EUROPE		NUM.	
TYPE:			
MOD.: E88A		V	kW
CE		M	

Given the type and height of this built-in oven, it can be installed only in a full-height kitchen unit.

Particular care must be given to the instructions on installing the oven in the unit, especially the indications regarding the size and position of the ventilation opening, which is essential for proper cooling of the enclosure and of the oven itself.

To guarantee the safety of the user, the unit housing the oven must be manufactured from materials able to withstand temperatures up to 90 °C. This includes core materials, laminates, facings and adhesives.

## CONTROL PANEL

### - 4 functions (4F+ Ø) Electronic Programmer

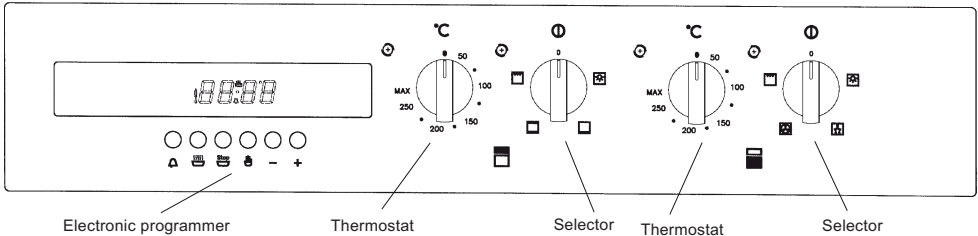

### - 9 functions (9F+ Ø) Electronic Programmer

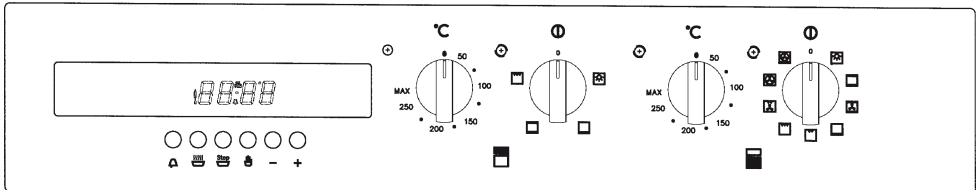

**- 4 functions (4F+ Ø) Timer 0-60**

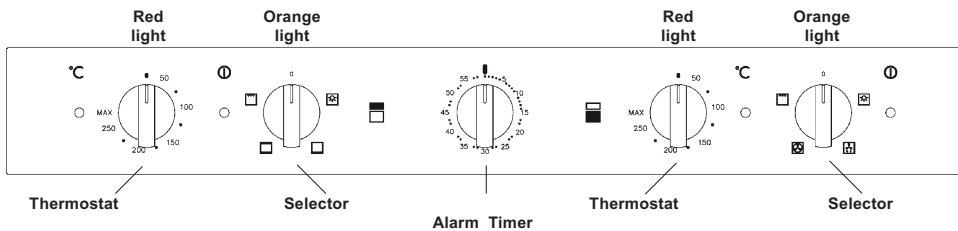

**- 7 functions (7F+ Ø) Timer 0-60**

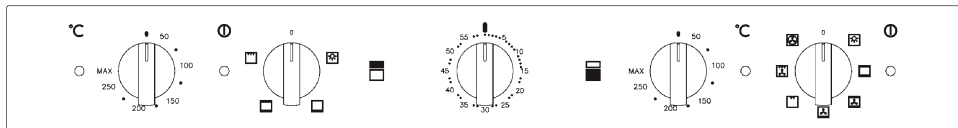

**- 4 functions (4F+ Ø) Timer 0-120**

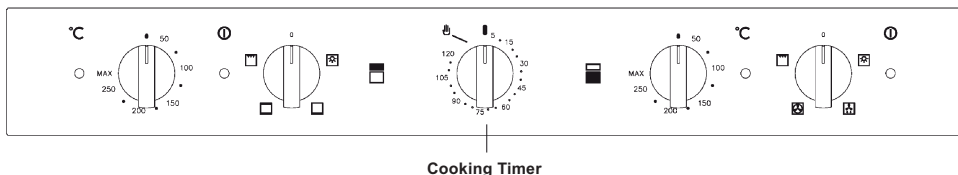

**- 7 functions (7F+ Ø) Timer 0-120**

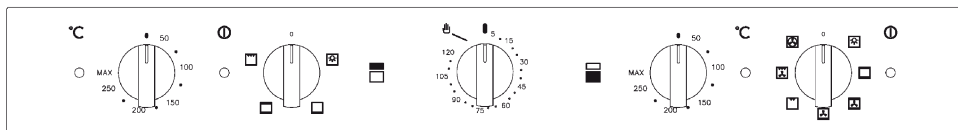

**- 4 functions (4F+ Ø) Electronic Programmer**

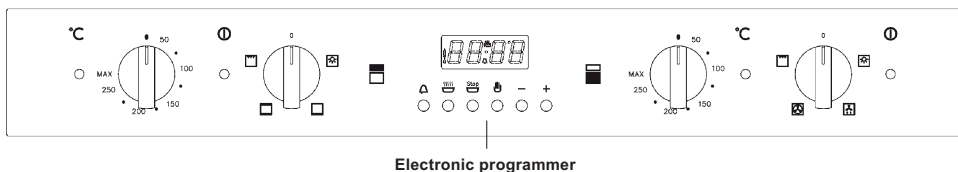

**- 7 functions (7F+ Ø) Electronic Programmer**

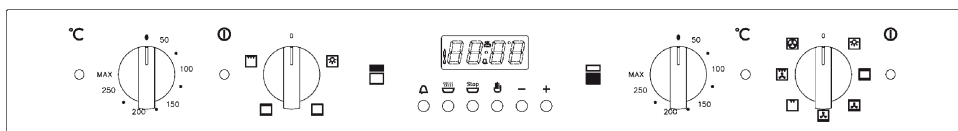

## TOP OVEN

The oven offers a basic choice between two types of cooking:

A) conventional oven cooking

B) grill (infrared radiant heat)

### Selector functions:

Position 0: The oven is switched OFF

Position 1: Oven interior light (turn to the right)



Position 2: Lower heating element



Set the required temperature between 50 and 250 °C. This setting is used typically for food to be reheated or warmed.

Position 3: Conventional cooking



Set the required cooking temperature between 50 and 250 °C. The red light will go out as soon as the selected temperature has been reached. The oven should be heated before any food is put in to cook.

Position 4: Grill



Set the thermostat at a temperature between 50 and 250 °C. The red light will go out as soon as the selected temperature has been reached.

The oven should be heated for a few minutes before food is put under the grill (Whether the door is open or closed).

### Oven accessories:

Oven grid

Flat biscuit tray

## MAIN OVEN

The oven offers a choice between two types of cooking:

- A) fan-assisted oven cooking
- B) grill (infrared radiant heat).

Selector functions: 4 functions (4F+ Ø)

Position 0: The oven is switched OFF

Position 1: Oven interior light



Position 2: Defreezing



The oven interior light and the orange warning light remain on — as is normally the case during all other functions of the oven — and the fan will come into operation, though without any heat being generated (thermostat off). The oven door must be kept closed. Using the oven in this way, food will defreeze in a third of the time normally needed.

Position 3: Fan-assisted cooking



The fan and the relative heating element come into operation, and heat will be distributed uniformly around the entire chamber at the temperature selected with the thermostat, between 50 and 250 °C. The oven should be heated before any food is put in to cook. Different types of food can be cooked simultaneously.

Position 4: Grill



Set the thermostat at a temperature between 50 and 250 °C. Keep the oven door closed. This type of grilling is especially suitable for small quantities of food. Keep the door closed.

Oven accessories:

Oven grid

Grill pan with grid

Handles for grill pan - For removing pan from the oven

## Selector functions: 7 functions (7F+ 0)

Position 0: The oven is switched OFF

Position 1: Oven interior light



Position 2: Conventional cooking



Set the required cooking temperature between 50 and 250 °C. The red light will go out as soon as the selected temperature has been reached. The oven should be heated before any food is put in to cook.

Position 3: Traditional cooking + Fan assisted



Set the thermostat between 50 and 250°C.

This cooking mode integrate natural convection and fan. Cooking mode suited to bake bread, pizzas and lasagne.

Position 4: Fan + Bottom heating element



Set the desired temperature for this very delicate and slow cooking mode. We suggest you do not pre-heat the oven.

Position 5: Middle Grill



Use the thermostat to the desired temperature between 50 and 250 °C, while keeping the oven door closed. This cooking mode is ideal for small amounts of food. Keep the door closed.

Position 6: Fan + Double Grill



Set the thermostat to the desired temperature between 50 and 250 °C. Fan operation combined with the grill lets you cook particular foods quickly and deeply. We suggest you pre-heat the oven for a few minutes before inserting food. Keep the door closed.

Position 7: Fan-forced cooking



The fan and the relative heating element come into operation, and heat will be distributed uniformly around the entire chamber at the temperature selected with the thermostat, between 50 and 250 °C. The oven should be heated before any food is put in to cook. Different types of food can be cooked simultaneously.

### Oven accessories:

2 x wire shelves

1 x grill pan



## Selector functions: 9 functions (9F+ Ø)

Position 0: The oven is switched OFF

Position 1: Oven interior light



Position 2: Conventional cooking



Set the required cooking temperature between 50 and 250 °C. The red light will go out as soon as the selected temperature has been reached. The oven should be heated before any food is put in to cook.

Position 3: Traditional cooking + Fan assisted



Set the thermostat between 50 and 250°C.

This cooking mode integrate natural convection and fan.  
Cooking mode suited to bake bread, pizzas and lasagne.

Position 4: Lower heating element



Set the required temperature between 50 and 250 °C. This setting is used typically for food to be reheated or warmed.

Position 5: Middle Grill



Use the thermostat to the desired temperature between 50 and 250 °C, while keeping the oven door closed. This cooking mode is ideal for small amounts of food. Keep the door closed.

Position 6: Grill



Set the thermostat at a temperature between 50 and 250 °C.

The red light will go out as soon as the selected temperature has been reached.

The oven should be heated for a few minutes before food is put under the grill. Keep the door closed.

Position 7: Fan + Double Grill



Set the thermostat to the desired temperature between 50 and 250 °C. Fan operation combined with the grill lets you cook particular foods quickly and deeply. We suggest you pre-heat the oven for a few minutes before inserting food. Keep the door closed.

Position 8: Fan-forced cooking



The fan and the relative heating element come into operation, and heat will be distributed uniformly around the entire chamber at the temperature selected with the thermostat, between 50 and 250 °C. The oven should be heated before any food is put in to cook. Different types of food can be cooked simultaneously.

Position 9:



*Fan-forced cooking + lower heating element*

The fan, circular heating element and bottom heating element come on. Temperature can be adjusted between 50 and 250 °C. This cooking mode is ideal for pizzas and other foods that require heat from below.

*Oven accessories:*

2 x wire shelves

1 x grill pan

## COOKING TABLE FOR TOP OVEN - CONVENTIONAL COOKING

IN HEATING SYSTEM WITH TOP AND BOTTOM HEATERS OPERATING. It is recommended to preheat the oven 10 min.

DISHES	LEVEL	TEMPERATURE	COOKING TIME
Yorkshire Puddin	1	200°C	30 - 40 min
Fatless Sponge Cake	1	180°C	25 - 30 min
Small Cakes	2	190°C	15 - 20 min
Fruit Plate Tart	1	200°C	40 - 45 min
Scones	2	220°C	10 - 15 min
Rich Fruit Cake	1	140°C	2 - 3 hours

## COOKING TABLE FOR THE TOP OVEN WITH INFRARED HEATER OPERATING

Grilling is carried out at the door closed. 5 minutes oven preheating is recommended. Setting possibility from 50 - max (250)°C. Food is placed on the backing pan grid.

DISHES	LEVEL	TEMPERATURE	COOKING TIME	
			Side 1	Side 2
Pork steaks, Chops (4 pcs)	3	225°C	12 min	10 min
Grilled Sausages (6 pcs)	3	225°C	6 min	5 min
Toast (6 pcs)	3	225°C	1 min/25 sec.	1 min/10 sec.

## COOKING TABLE FOR THE MAIN OVEN WITH INFRARED HEATER OPERATING

Grilling is carried out at the door closed. 5 minutes oven preheating is recommended. Setting possibility from 50 - max (250)°C. Food is placed on the backing pan grid.

DISHES	LEVEL	TEMPERATURE	COOKING TIME	
			Side 1	Side 2
Pork steaks, Chops (4 pcs)	Topmost 5	250°C	15 min	12 min
Roast beef (4pcs)	Topmost 5	250°C	10 min	8 min
Grilled Sausages (6 pcs)	Topmost 5	250°C	9 min	6 min
Toast (6 pcs)	Topmost 5	250°C	1 min/50 sec.	1 min/30 sec.

## USING THE OVENS



Set the selector for the type of cooking required.

Preheat the oven, setting the thermostat to the required temperature. Once the oven has heated to the selected temperature, the orange warning light will go out. This same light will appear again automatically during operation of the oven to indicate that the heating elements are on.

Remove the drip tray when using the oven for conventional baking, roasting etc. The tray should be left in place only when using the grill, as its purpose is to catch falling droplets of fat. Food should be placed in oven dishes with raised edges and positioned centrally under the grill. If fan-forced operation is selected, foods of different types can be cooked simultaneously (e.g. meat and fish), although in this case the respective cooking time must be observed.

**If selecting the  position, temperatures must be set 10 to 20°C lower than indicated in the table.**

### Cooking temperatures and times

Dish	Temperature in degrees centigrade	Approximate cooking time in minutes
	 	
<b>Sweets</b>	175 160	55-65
Short pastry flan base	200 190	8-10
Fruit pie/tart	200 190	25-35
White leavened bread per 1 kg flour	200 190	30-50
Shortcake biscuits	200 190	10-15
Savoury biscuits	200 190	15-20
Lasagne	225 210	40-50
<b>Meat</b> (cooking time based on thickness)		
Slow roast	175 170	12-15
Quick roast	200 190	12-15
Meat loaf	200 190	30-40
<b>Poultry</b>		
Duck 1.5 -2 kg	200 170	120-180
Goose 3 kg	200 180	150-210
Roast chicken	200 190	60-90
Turkey 5 kg	175 150	240 ca.
<b>Game</b>		
Hare	200 180	60-90
Leg of roebuck	200 180	90-150
Haunch of venison	175 175	90-180
<b>Vegetable</b>		
Vegetable soufflé	200 180	40-45
Fish	180 170	40-45
Pizza	210 200	20-25
<b>Grills</b>		
Pork chop		8-12
Sausage		10-12
Grilled chicken		25-35

## ROASTING GUIDE

- Frozen meat should be thoroughly thawed before cooking. For large joints it is advisable to thaw overnight.
- Frozen poultry should be thoroughly thawed before cooking, the time required depends on the size of the bird e.g. a large turkey may take up to 48 hours to thaw.
- Adjust the shelf position so the meat or poultry will be in the centre of the oven.

The TIMES given in the ROASTING GUIDE are only approximate because the size and age of the bird will influence cooking times as will the shape of a joint and the proportion of bone.

Cook in oven 180°C (Fan oven) 200°C (Conventional oven)		Approximate cooking time
BEEF	Rare Medium Well Done	20 minutes per 450g. (1lb) plus 20 minutes 25 minutes per 450 g (1 lb) plus 20 minutes 30 minutes per 450 g (1 lb) plus 30 minutes
LAMB	Medium Well Done	25 minutes per 450 g (1 lb) plus 25 minutes 30 minutes per 450 g (1 lb) plus 30 minutes
PORK		35 minutes per 450 g (1 lb) plus 35 minutes
FOWL		20 minutes per 450 g (1 lb) plus 20 minutes

### Notes:

If you are cooking a very large turkey e.g. over 141lb., we recommend that it is turned around halfway through cooking, so that both legs will be cooked evenly. Remove any excess fat from the tin before turning, to prevent any fat splashing. When cooking stuffed meat or poultry calculate the cooking time from the total weight of the meat plus the stuffing.

For joints cooked in foil or covered roasters, and for lidded casseroles, add 5 minutes per 450g. (1lb. to the calculated cooking time.

Smaller joints weighing less than 1.25 k.g. (2 lb.) may require 5 minutes per 450g. (1lb) extra cooking time.

## DEFROSTING AND COOLING (only for 4F)



To defrost frozen foods, turn the oven control to the defrost position, place the food in the centre of the oven and close the door.

### Be safe

- X** DO NOT defrost stuffed poultry using this method.
- X** DO NOT defrost larger joints of meat and poultry over 2kg.(4lb) using this method.
- X** NEVER place uncooked food for defrosting next to cooked food which is to be cooled, as this can lead to cross contamination.

Defrosting meat, poultry, and fish can be accelerated using this method but make sur they are completely thawed before cooking thoroughly. Place meat and poultry on a trivet in a meat tin.

### Defrosting times

- 👉 Small or thin pieces of frozen fish or meat e.g. fish fillets, prawns, and mince will take approximately 1-2 hours. Placing the food in a single layer will reduce the thawing time.
- 👉 A medium sized casserole or stew will take approximately 3-4 hours.
- 👉 A 1 1/2 kg (3lb) oven ready chicken will take approximately 5 hours, remove the giblets as soon as possible.

## INSTRUCTIONS FOR USE

### General instructions

**CAUTION:** the oven door becomes hot during use. Be sure to keep children well away!

Do not use the oven as a room heater.

Always be very careful when connecting other electrical appliances to the power supply if these are situated near the oven: the power cables must not come into contact with hot parts of the oven.

To ensure the oven will always be safe, any servicing — especially of electrical parts — should be entrusted exclusively to a skilled professional.

Clean the oven every time after use: this will make it easier to remove dirt and grease and ensure that deposits do not build up.

Use earthenware oven dishes enamelled steel or pyrex - type glass for roasting and baking, selecting a suitable size for the bulk and quantity of the food being cooked.

Stainless steel ovenware is not recommended, as the metal reflects heat.

If the interior light should fail, disconnect the oven from the electrical power before removing and replacing the lamp.

### Using first time

Before using the oven for the first time, clean the interior thoroughly with liquid detergent and lukewarm water. Wipe off, then heat the oven to maximum temperature and leave on for 20 minutes. This will ensure that residual oil and grease used in the manufacturing process do not give off unpleasant smells when food is cooked in the oven.

Once this has been done, the oven is ready for use.

**CAUTION:** make certain the oven is disconnected from the electrical power supply before carrying out any cleaning operation on the oven.

### Final checks

Having installed the oven in its enclosure, and before switching on, be certain to check that there are no live parts accessible, and that all the packing has been removed.

At this point the oven can be switched on as described in the instructions.

## INSTALLATION



**CAUTION:**  
**THIS APPLIANCE MUST BE INSTALLED BY A PROFESSIONAL ELECTRICIAN, AND IN ACCORDANCE WITH THE MANUFACTURER'S INSTRUCTIONS BEFORE CARRYING OUT ANY ADJUSTMENT OR REPAIR ON THE APPLIANCE, MAKE CERTAIN IT IS DISCONNECTED FROM THE ELECTRICAL POWER SUPPLY**

### Statutory regulations, technical standards, directives

The appliance must be installed in conformity with current statutory regulations and in accordance with applicable safety standards.

### Installing the oven

The unit in which the oven is installed must be manufactured to a modular dimension of 600mm.

Openings at least 50 mm deep must be cut both in the bottom and in the top of the unit to ensure adequate ventilation (see figure1 for essential dimensions).

During assembly, particular care must be taken not to pick up the oven by the door. As a general rule, the oven door should never be forced or subjected to undue stresses.

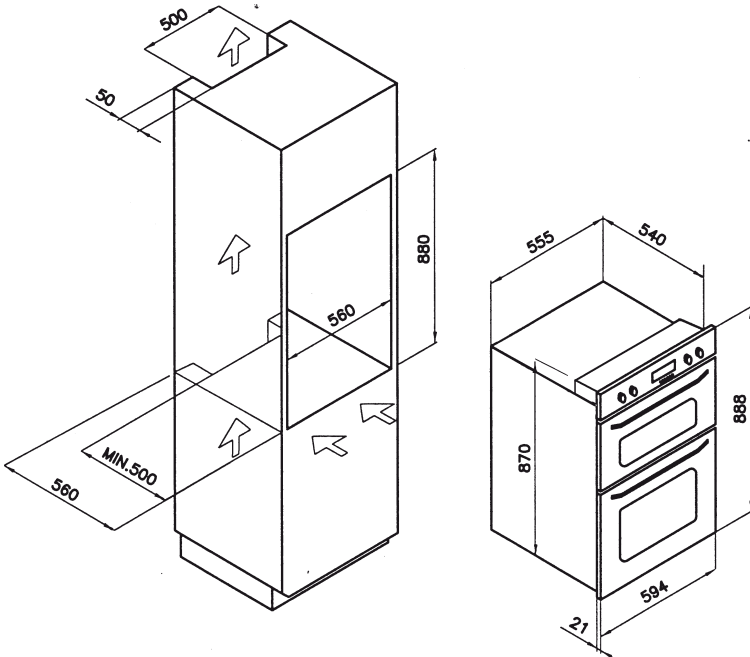



## Electrical connection

Make certain the nominal a.c. power supply voltage corresponds to that indicated on the identification data plate. The appliance must be connected to the supply by way of an isolating switch with minimum contact separation of 3 mm. Suitable isolating components include automatic breakers, fuses and relays.

The oven must be connected to an efficient earth system, as prescribed by national and/or local statutory regulations.

The cable must be connected as prescribed by statutory regulations and respond to the specifications indicated on the Technical Data page.

The terminal box is located at the rear of the appliance. If a new cable is fitted, route it through the clamp and make the connections as shown in the diagram. The earth wire must be cut longer than the other wires so that it will be the last to break off in the event of the cable being tugged.

Having made the connection, tighten the cable clamp and close the cover of the box.

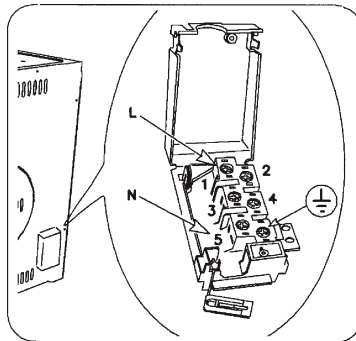

### CONNECTION DIAGRAM

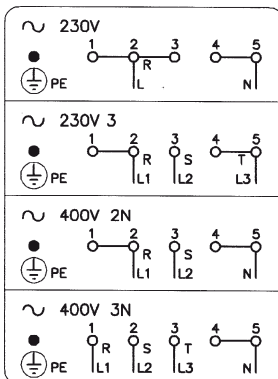

### CABLE TYPES AND SECTIONS

#### H05RR-F

230V~ 3 x 2,5 mm<sup>2</sup>

230V 3 4 x 1,5 mm<sup>2</sup>

400V 2N~ 4 x 1,5 mm<sup>2</sup>

400V 3N~ 5 x 1,5 mm<sup>2</sup>

## ELECTRONIC PROGRAMMER





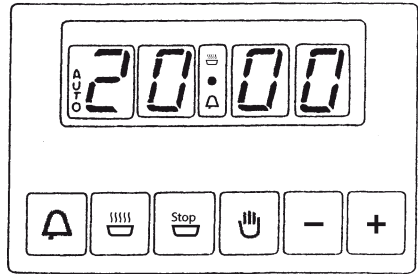

The electronic programmer incorporates the following functions:

- 24 hour clock with luminous display
- 10 hour timer
- automatic oven cooking
- semiautomatic oven cooking

The electronic programmer operate only on the “large” oven.





### Programming buttons and their functions.

-  beep
-  cooking time in automatic mode
-  cooking stop time
-  manual operation
-  decrease – all programs
-  increase – all programs

### Luminous symbols





When “**AUTO**” blinks, this means that the timer is in “automatic” mode but no setting has yet been made.

When “**AUTO**” remains permanently alight, this means that the timer is in “automatic” mode and already programmed

-  automatic cooking
-  timer in operation
-  plus “**AUTO**” blinking: programming error

If there is no symbol alight other than the digits of the clock, this means that the timer is in “manual” mode.

### Digital clock

The timer incorporates a digital electronic clock with luminous numbers indicating the hours and minutes. When the appliance is first connected to the a.c. supply, or following a power cut, three zeroes will blink in the timer window. To set the clock press the two buttons  and  together, release and then use the  or  symbol to select the exact time. The longer the increase or decrease button is held,

the faster the numbers will scroll.

If convenient, the clock can be turned back to **00.00**:

to scroll back further at this point, release all the buttons and repeat the sequence, pressing and holding the decrease button until the time appears in the display.

### Normal cooking without using the timer

To operate the oven in manual mode — in other words without using the timer— the blinking **“AUTO”** indicator must be deactivated by pressing the  button.

### Automatic cooking (programmed start and stop times)

To cook food in the oven using the automatic timer, proceed as follows:

- establish how long the food needs to cook 

- enter the cooking stop time 

- select the temperature and the cooking method.

Once these steps have been completed, the **“AUTO”** indicator will light up permanently in the display, confirming that the oven has been programmed.

Practical example: we want to cook food for a period of 30 minutes, ending at 14.00.

- Pressing and holding , enter 0.30 in the display.



- Pressing and holding , enter 14.00 in the display.



This done, the display will revert to the current time and **“AUTO”** reappears, confirming that the settings have been acknowledged and memorized. At 13.30 (14.00 minus 30 minutes) the oven switches on automatically and the symbols and **“AUTO”** will appear for as long as cooking continues. The oven will then switch off automatically at 14.00, triggering a beep that can be silenced by pressing .

### Semiautomatic cooking



A. Programming the duration

B. Programming the stop time.

A) Select the duration for which the food is to cook by pressing . The oven will switch on immediately, with the symbols **“AUTO”** and  showing in the display. Once the set duration has elapsed, cooking will stop and the beep sounds intermittently. Silence the beep as indicated above.

B) Set the time for cooking to stop, by pressing . The oven will switch on immediately, with the symbols **“AUTO”** and  showing in the display. When the set time comes around, cooking will stop and the beep sounds intermittently. Silence the beep as indicated above.

Current programming status can be displayed at any given moment by pressing the corresponding button.

It is also possible to cancel the current selection at any moment by pressing  and resetting the display to zero. Pressing  at this point, the programmer will revert to manual mode.

**CAUTION:** if the oven is disconnected from the power supply, or in the event of a power failure, the clock resets to zero and all programming will be lost. When power is restored, three zeroes appear.

## ALARM TIMER

You can set this timer to sound a buzzer after 0 to 60 minutes of cooking. First turn the knob fully clockwise, then turn it back to the desired alarm time.

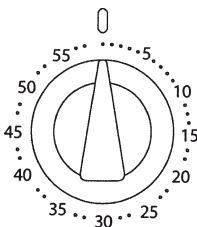

## COOKING TIMER

First, turn the cooking selector to the required cooking function, and the thermostat to the desired cooking temperature.

Then, to set end of cooking time, turn the cooking timer to the right and to the desired time. First turn the knob fully clockwise, then turn it back to the desired alarm time. A buzzer sounds at the end of the timed cooking period, and the oven switches itself off.

To set only the start of cooking, turn the cooking timer to the left to the  symbol.

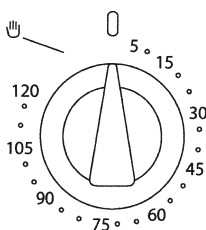

## CLEANING AND MAINTENANCE

Never clean the oven with the high- pressure steam cleaning device, as it may provoke short circuit.

Before cleaning switch the cooker off and let it cool down completely.

### **Front side of the casing**

For cleaning of frontal part of the cooker use the usual cleaning agents and follow the manufacturer's instructions.

Never use any aggressive cleaning agents or dish cleaning accessories which might cause scratches. For the front door glass use soft cloth and liquid cleaners for clinig glass surfaces.

### **Stainless steel front**

Clean the surface with mild detergent (soap) and soft sponge which does not scratch. Never use aggressive cleaners or solvents, otherwise you may damage the surface.

### **Enamel coated and plastic surfaces**

Clean the knobs and handles with soft cloth and liquid cleaners, intended for use of smooth ename surfaces.

### **Oven**

The oven may be cleaned in a traditional mode (using oven cleaners and sprays). Otherwise respect the following cleaning tips:

- Cool the oven completely before cleaning.
- The oven and the accessories must be cleaned after each use, otherwise stains might get burned in.
- Oven walls, sprayed with oil from roasting, is best cleane with warm water and detergent when the oven is still tepid.
- Hard and heavily stained oven should be cleaned with special oven cleaning agents. Rinse the cleaner thoroughly and remove any detergent remaining before the next use.
- Never use aggressive cleaners, like polishing agents, dish cleaning accessories, corrosion inhibitors, or any other devices that might cause scratches.
- Coated, stainless steel or zinc-coated surfaces or aluminum parts must not come into contact with oven sprays, since they might cause damage or discoloration. The same goes for thermostat probe (if the cooker is equipped with it) and exposed heaters on the ove ceiling.
- When purchasing cleaning agents remember the environment, and strictly follow the manufacturer's instructions.

**IMPORTANT:** before carrying out any maintenance operations on the oven, set the automatic isolating switch to the off position.

The oven's side runners can easily be removed by disconnecting them from the peg in the bottom, turning them towards the inside of the oven and extracting them from the supporting holes.

To put them back in place, reverse this procedure.

Clean the side grids only with conventional detergents.

Removing wire grids.

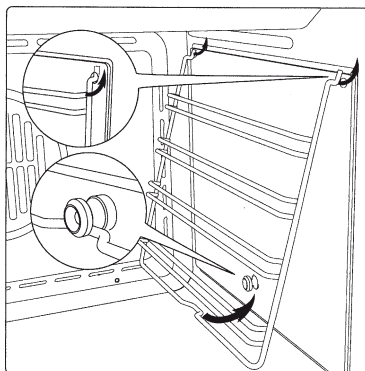

## TECHNICAL DATA

### Dimensions

- height	mm	888
- width	mm	594
- depth	mm	550
- usable volume		58 + 32 litres

This appliance is manufactured in compliance with RF suppression standards.

- MODEL	Multifunction oven
- RATED VOLTAGE	230/240 - 400/415 V 3N
TOP oven	
	Nominal electrical input in W (toll. +5 /-10%)
- interior light	25 W
- tangential fan unit	20 W
- upper heating element	750 W
- grill element	1750 W
- lower heating element	850 W
- maximum electrical input	1795 W

<b>MAIN oven (4F)</b>	
	Nominal electrical input in W (tol. +5 /-10%)
- interior light	25 W
- radial fan unit	30 W
- tangential fan unit, large oven	10 W
- circular heating element	2300 W
- grill element	2000 W
- Maximum electrical input	2365 W
<b>- Maximum overall electrical input</b>	4250 W 230-240V / 3700 W 220V
<b>- Power cable</b>	HO5 RN- F 3 x 2,5 mm <sup>2</sup> section
<b>MAIN oven (7F)</b>	
	Nominal electrical input in W (tol. +5 /-10%)
- interior light	25 W
- radial fan unit	30 W
- tangential fan unit, large oven	10 W
- circular heating element	2300 W
- middle grill	1200 W
- double grill	2200 W
- upper heating element	1000 W
- lower heating element	1100 W
- Maximum electrical input	2365 W
<b>- Maximum overall electrical input</b>	4250 W 230-240V / 3700 W 220V
<b>- Power cable</b>	HO5 RN- F 3 x 2,5 mm <sup>2</sup> section
<b>MAIN oven</b>	
	Nominal electrical input in W (tol. +5 /-10%)
- interior light	25 W
- radial fan unit	30 W
- tangential fan unit, large oven	10 W
- circular heating element	2300 W
- middle grill	1200 W
- double grill	2200 W
- upper heating element	1000 W
- lower heating element	1100 W
- Maximum electrical input	3465 W
<b>- Maximum overall electrical input</b>	5350 W 230-240V / 4700 W 220V
<b>- Power cable</b>	HO5 RN- F 3 x 2,5 mm <sup>2</sup> section

## INTERIOR LIGHT: REPLACING THE LAMP

**CAUTION:** Disconnect the appliance from the power supply.

To replace the lamp of the oven interior light, first unscrew and remove the protective cover A.

Renew the lamp, and refit the cover A.

Max power 25 W.

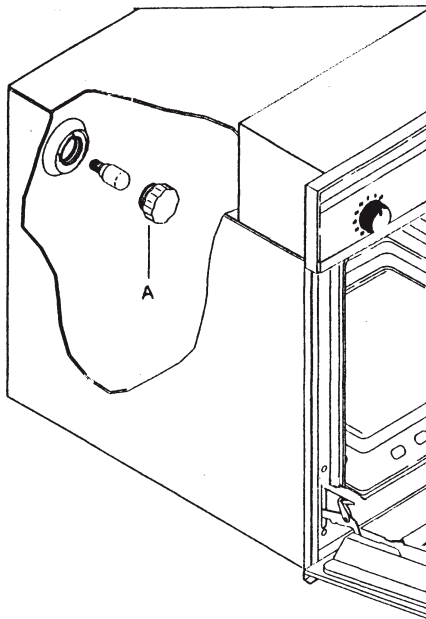



## REMOVING THE OVEN DOOR

The door is easily removed, as follows:

- open the door completely;
- raise the two hinge levers as indicated in the drawing;
- close the door again until a click is produced by the levers raised previously;
- lift the door upward and away from the front of the oven to free it from the sockets;

To refit the door, locate the hinges in the sockets and return the two levers to the locking position.

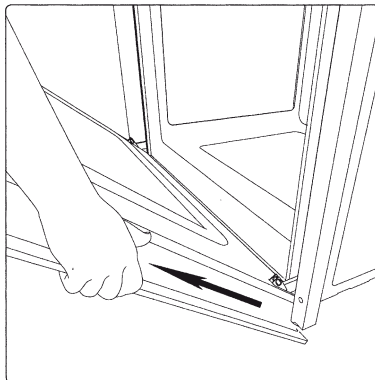
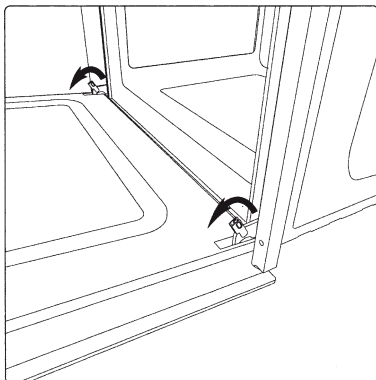





---

The manufacturer declines any responsibility for possible inaccuracies in the present publication attributable to copying and printing errors. The right is reserved by the manufacturer to make such changes to products as are deemed necessary or appropriate, without affecting their essential characteristics.

---

**COD. 2.000.19.2 - 4°ed**